

INSTALLATION INSTRUCTIONS AND OPERATIONS MANUAL

CARDALE
GARAGE DOORS

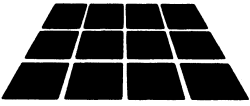

STEEL-LINE DOORS

The new Cardale Door has been designed to provide effortless operation, security and attractive appearance. The door will perform efficiently if it is installed correctly.

IMPORTANT NOTE – For electrically operated doors read instruction booklet for operator installation prior to installing door

PLEASE READ THESE INSTRUCTIONS CAREFULLY BEFORE COMMENCING THE INSTALLATION

SECTION 1: Pre-Installation Checks

A Roller Door is designed to be fitted behind the opening so the following dimensions and conditions need to be checked, before fully unpacking the door for installation.

1. OPENING WIDTH Check that the door curtain supplied overlaps the opening width by a minimum of:

- (a) 25mm each side for doors supplied with 25mm deep tracks.
- (b) 50mm each side for doors supplied with 50mm deep tracks.
- (c) 35mm each side for doors supplied with rollguard tracks.

2. SIDE CLEARANCE The minimum side clearances are:-

DOOR TYPE	Minimum side clearance per side	
	Manual door	Automatic door
'A' series (25mm deep tracks)	90mm	120mm
'AA' series (50mm deep tracks)	120mm	150mm
All doors with rollguard tracks	150mm	150mm

3. OPENING HEIGHT Your door will fit any opening height up to that stated on the package.

4. HEADROOM A minimum clearance between the underside of the lintel and the ceiling. This varies with height of opening. See chart. (FIG 1).

This clearance must extend for minimum of 500mm back from the opening.

NOTE: The headroom stated in chart (Fig 1) is only necessary if the whole door roll is to be hidden when viewed from outside the garage. It is possible to use less headroom than that stated but there will be a corresponding reduction in door open height.

5. STRUCTURAL CONDITION OF OPENING

ENSURE THE AREA AROUND THE OPENING IS STRONG ENOUGH TO SUPPORT THE DOOR

The surface where the door is to be fitted must be flush and reasonably smooth. Small irregularities in brickwork will be acceptable. The lintel must not protrude backwards or forwards from the brick piers. Should the lintel protrude backwards or forwards from the brick piers this will require special instructions, please consult your Cardale dealer.

6. FITTING NOTES

- (a) For doors over 2.5 metres wide it is recommended that 2 people are available for fitting.
- (b) **THE DOOR MUST BE FITTED SQUARE AND LEVEL, IRRESPECTIVE OF THE SHAPE OF THE OPENING. ON NO ACCOUNT SHOULD ANY COMPENSATION BE MADE TO SUIT AN IRREGULAR OPENING.** (FIG.2)
- (c) Ensure all necessary tools are to hand before starting.
- (d) The door package and its contents should be checked for obvious damage before removal of the wrapping. (FIG. 3 and 4).

IF THERE IS ANY DAMAGE YOUR SUPPLIER SHOULD BE CONTACTED IMMEDIATELY.

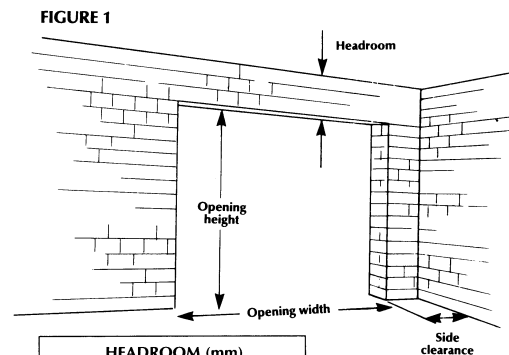

HEADROOM (mm)	
7' 0" (2134)	380
8' 0" (2438)	405
9' 0" (2743)	430
10' 0" (3048)	455

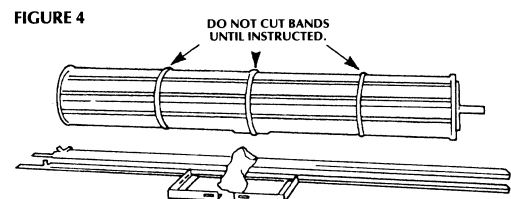
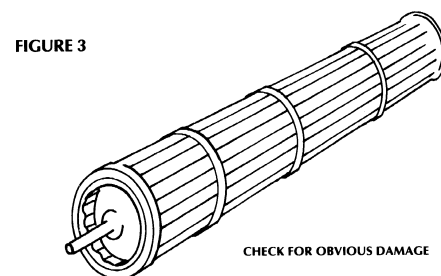
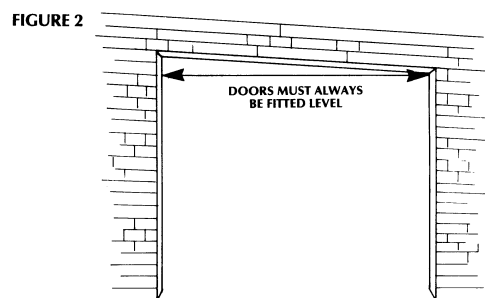

SECTION 2: Installation

TOOLS NEEDED FOR DOOR FITTING: Stanley Knife, Tape Measure, Pencil, Spirit Level (1 metre), 17mm Socket, 10mm Socket, 13mm Socket, Electric Drill, Masonary Drill, Drill Bits (various), Hacksaw, 18" Stilson, Hammer, Screwdriver, Square File.

HANDLE DOOR ROLL CAREFULLY TO AVOID DAMAGE

1. MARK DOOR POSITION From the pre-installation check you have determined that the door supplied fits the opening correctly. Mark curtain overlap (1) at each side of the opening so that the positions of the support brackets can be chosen (FIG. 5).

2. FIX BRACKETS The brackets should be fixed outside the curtain overlap marks in accordance with dimensions in FIG 5. 8mm x 50mm long coach screws and washers are provided for fixing to timber or for use with plastic plugs in brickwork.
NOTE: The dimension shown is the minimum clearance required for each door height. If more headroom is available than that shown in Fig 1 then this dimension should be adjusted accordingly.

ENSURE THAT THE BRACKETS ARE PERFECTLY LEVEL WHEN FIXED.

3. MOUNT DOOR TO BRACKETS

- Whilst the door is on the floor rotate the axle back and forward through the roll to centre it. (FIG. 6)
- Check axle length does not foul any obstructions. Cut down if necessary.
- Lift the door onto the brackets after ensuring that the roll is correct way round. With bottom rail/weather seal pointing up inside the garage. (FIG. 7)
- Fit a 'U' bolt, nut and washers loosely at each support bracket. (FIG. 7)

4. POSITION DOOR

- Centre the door roll in the opening by lifting and pushing the axle either way.
- Tighten the 'U' bolts with the axle 210mm-250mm from the lintel and the aluminium bottom rail at the start position shown in Fig. 7.

WARNING BEFORE THE TRACKS ARE FITTED BE VERY CAREFUL NOT TO ALLOW THE CURTAIN TO ROLL UP UNAIDED AS DAMAGE AND INJURY MAY RESULT.

THIS NEXT OPERATION CAN BE DONE BY ONE MAN BUT FOR DOORS OVER 2.5 METRES WIDE IT IS RECOMMENDED THAT 2 MEN CARRY IT OUT.

5. PRETENSION Pretension should now be applied to the springs by turning the roll approx. 1½-2 turns forward (SEE FIG. 7). The amount of pretension may vary with individual doors and applications. (See section 3-5 – adjustments)

6. UNROLLING DOOR

Still holding the door in its tensioned state, with aluminium rail adjacent to the lintel, carefully cut the bands holding the door in a roll and slowly pull the curtain down to the floor. Standing inside the garage, remove cardboard banding tape. Then carefully allow the curtain to re-roll ensuring the bottom rail stays level and the curtain rolls up evenly with the edge of the tape rolling up over itself. With approx ½ metre left unrolled, take the piece of your cardboard packaging and wedge it between the door curtain and the door roll. This will prevent the door rolling up any further. (SEE FIG. 10)

7. CUT TRACKS Measure from the top horizontal edge of each support bracket to the floor (Dimension A). Cut each track accordingly measuring from the extreme top of the track and cutting any surplus from the bottom. (SEE FIG. 11)

FIGURE 5 : FIX BRACKETS

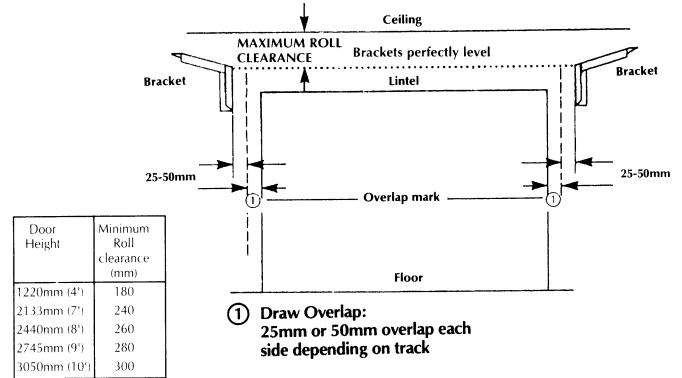

FIGURE 6

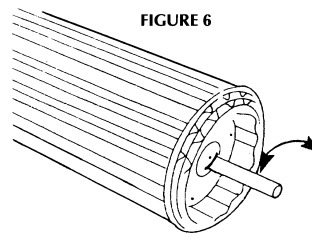

FIGURE 7

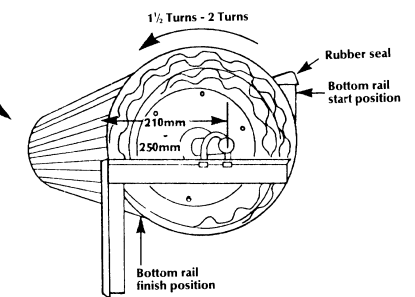

FIGURE 8

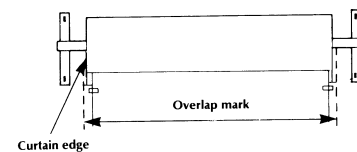

FIGURE 9

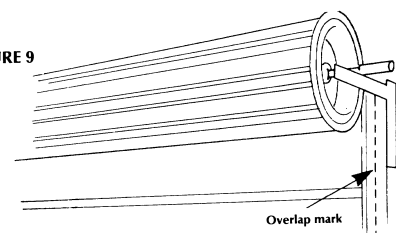

FIGURE 10

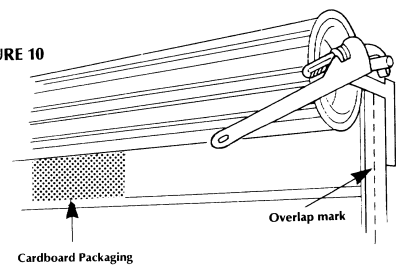
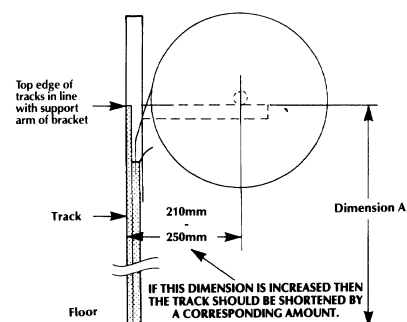

FIGURE 11 : CUT TRACK



8. FIT TRACKS

- Ensure that the curtain has remained square by checking it against the overlap marks. (FIG. 8)
 - For doors supplied with 25mm deep tracks fit 3 lugs into track and position it over the edge of the curtain allowing it to slide fully into the track slot. (FIG. 12). Pull back lead-ins in track. (FIG. 13)
 - For doors supplied with 50mm deep tracks you will see that the fixing lugs are already fitted. It is only necessary to use one screw in each lug. (FIG. 13). Cut lead-ins to 2" (50mm) depth using hacksaw, and pull back (FIG. 13)
 - Push the track against the wall or frame and ensure that it is vertical and allowing approx. 2mm running clearance per side of track at the guide block fixed in the aluminium bottom rail. Drill wall or frame an fix top lug with 8mm x 45mm long coach screws supplied and plumb tracks and fit rest of fixing. (SEE FIG. 14)
- (e) Now do the same with the opposite track.

NOTE: THE EXTREME TOP EDGES OF THE TRACKS MUST NOT BE HIGHER THAN THE HORIZONTAL PARTS OF THE SUPPORT BRACKETS. IF THEY ARE THE DOOR WILL BE DIFFICULT TO FULLY CLOSE. (FIG. 11.)

9. ADJUST TRACKS You now have both tracks fitted onto the curtain and firmly fixed. Pull curtain down slowly and remove cardboard packaging. Continue to pull curtain down to the floor ensuring that it runs freely. If it does not, reposition the tracks as necessary. (FIG. 14).

The door is now installed and should open and close freely. It should not try to open or close on its own from the half open position. If door operation is satisfactory, proceed with 10.

10. CUT LOCK HOLES When you are satisfied with the door operation the lock bar holes must be cut into the tracks. (FIG. 15).

- Close the door fully and whilst pressing the weatherseal onto the floor, mark the position of each lock bar on its track.
- Cut a slot in the back of each track just large enough to accept each lock bar.
- Check that both lock bars pass through the slots freely when door is fully closed.

FIGURE 13

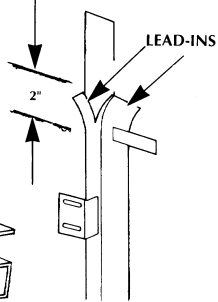

FIGURE 12

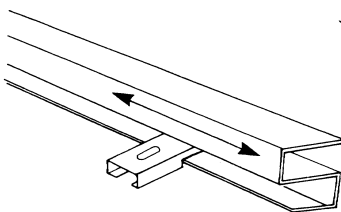

FIGURE 14

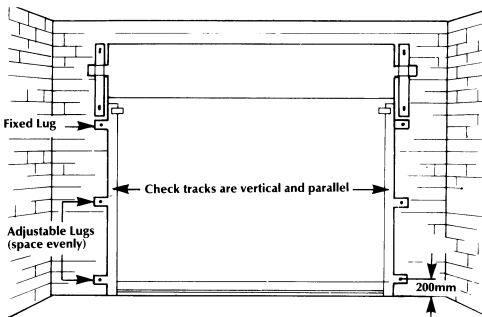
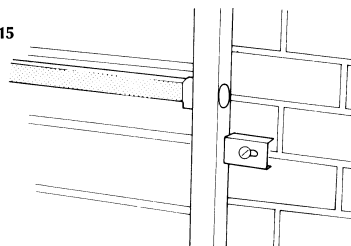

FIGURE 15



SECTION 3: Problem Check

1. DIFFICULT TO OPERATE IN EITHER DIRECTION

- Check that the curtain is not jamming in the tracks.
- Check running clearance in the tracks (2mm per side.)
- Check that the tracks are upright and clean. Lubricate with silicone spray only.

2. DIFFICULT TO CLOSE Decrease spring tension (See final spring adjustment para 5).

3. TRACK/SHAFT RELATIONSHIP (SEE FIG. 8). If the door is very difficult to close the last 600mm, check that the tracks are fitted in the correct relationship to the brackets and that the axle is the correct distance from the wall, ie. repeat Step 8.

One or both will be incorrect, thereby increasing lead angle into the mouth of the tracks, making the door difficult to close.

4. CONING (SEE FIG. 16) If the curtain rolls up unevenly (cones out at one end) and the bottom rail appears out of parallel with the door roll and tracks, check the following:

- Brackets not level.
- Axle not correctly centralised in roll. (FIG. 5).

If the brackets are level, remove the coning by moving the axle through the roll in the opposite direction to the coning.

FIGURE 16 : CONING

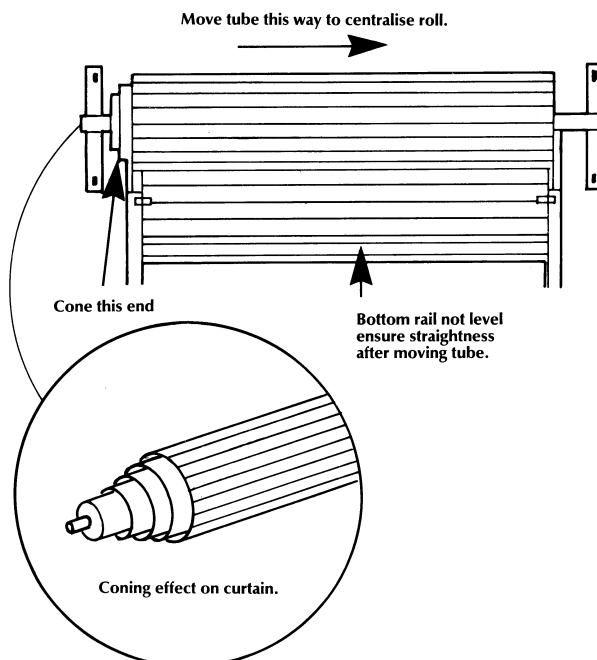

5. FINAL SPRING ADJUSTMENT

**THIS OPERATION CAN BE DONE BY ONE MAN.
BUT FOR DOORS OVER 2.5 METRES WIDE IT IS
RECOMMENDED THAT 2 MEN CARRY IT OUT.**

- (a) One 'U' bolt clamp should be selected to loosen first and the other should remain fully tightened. One 'U' bolt clamp will retain the tension **so long as the door is fully open.**

**THIS OPERATION SHOULD NOT BE ATTEMPTED WITH THE
DOOR UNROLLED AS THE TENSION IS VERY MUCH GREATER.**

- (b) Loosen the selected 'U' bolt clamp.
(c) Move to the other end of the door roll and with an 18" stilson, grip the axle firmly. Loosen the other 'U' bolt clamp until the axle is free.
(d) To increase tension pull down on the stilson and to decrease tension allow the stilson to move up (SEE FIG. 17).
(e) Fully tighten adjacent 'U' bolt clamp while holding tension with Stilsons. Do not release Stilson until 'U' bolts are tight.

If necessary repeat operation.

FIGURE 17

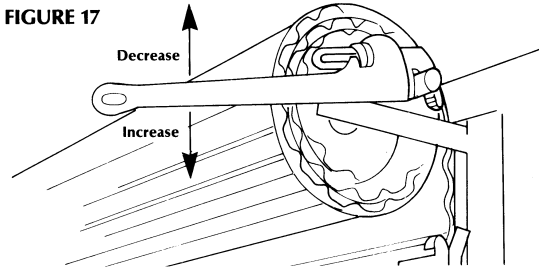

SECTION 4: Maintenance

Maintenance is not normally required but the following suggestions will keep the door working efficiently.

1. Do not grease or oil the tracks.
2. Periodically clean the inside of the tracks with methylated spirits or similar and spray with silicone spray or furniture polish.
3. It may be necessary to lightly oil the lock mechanism via the key hole occasionally if operation becomes difficult.
4. Periodically wash the finished surface of the door with soap and water remembering the area which is always exposed on the roll inside the garage when the door is closed.

CARDALE GARAGE DOORS

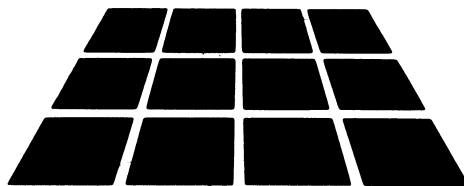

 **STEEL-LINE DOORS**

CARDALE DOORS
Farm Road, Brackley,
Northants. NN13 7EA
Telephone: 01280 703022 Fax: 01280 701138
0800 525 442

9th August '94
ISSUE B DPIN4970
www.thegaragedoorcentre.co.uk